

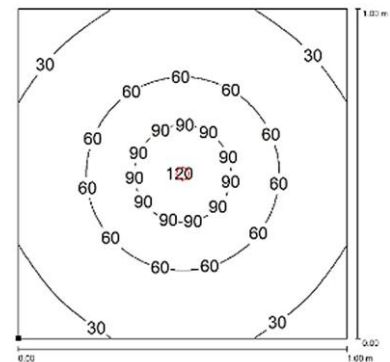

PRODUCT FEATURES

Power usage	3 W
Power supply	24 Vdc with LED Driver
Light source	LED
Electrical connection	Cable 1.5m (5ft)
Color temperature	5000K, CRI 80
Luminous flux	110 lm
Efficiency	37 lm/W
Light beam angle	60°
Housing	Anodized aluminum
Front protection	Tempered glass
Protection index	IP65
Impact resistance	IK06
Operating temperature	-20°C to + 45°C (-04°F to +113°F)
Weight	1,20 kg (2,65 lb)
Agency approvals	CE, RoHS
Mounting	CLAMPO4, B02, SCREW

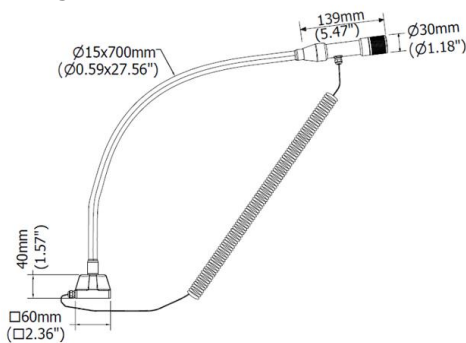

NOTE: Installation Height: 1m