



E506617  
LOW VOLTAGE LUMINAIRE

# HERIONOVA

## Series

# ENGLISH

## Installation Manual



## Table of contents

1. Product description .....	3
2. Safety Warnings .....	4
2.1 Proper use .....	4
2.2 Product safety .....	4
2.3 Risk levels.....	6
3. Available versions.....	7
4. Guide to installation .....	7
4.1 Product sizes .....	7
4.2 Mounting accessories.....	8
4.3 Installation... ..	9
5. Plug-in .....	11
5.1 Low voltage plug-in with M12 connector.....	11
5.2 Power cord .....	12
5.3 Integrated Power Cord .....	12
6. Switch on-Switch off .....	13
7. Problem solving .....	13
8. Light source replacement .....	13
9. Product maintenance and cleaning .....	13
10. Repairs.....	13
11. Warranty .....	14
12. Product Disposal .....	14
13. Technical data... ..	15
14. Meaning of symbol keys .....	16
15. Declaration of conformity.....	17



## 1. Product Description

- Led Lighting Equipment suitable for industrial machine tools.
- Anodized aluminum structure
- Tempered glass-front protection.
- Anti-dazzling internal prismatic diffuser.
- High power Led light source
- White homogeneous light
- Highly resistant to impacts, mechanical vibrations and processing shavings
- IP 67 degree of protection lamp
- Plug-in to 24VDC
- Four lengths available
- Use only with class 2 power supply
- Suitable for wet location
- For cabinet use only
- CAUTION: To reduce the risk of fire, do not install in a compartment smaller than 30cm by 30cm by length of product.
- Cabinet use also includes under-cabinet and surface mounting use, as applicable.

### On Request:

- 16 ft (5 m) power cord
- HNX01 Side-mounting brackets
- HNX02 Rear-mounting Arm
- FRAMES Recessed Version

## 2. Safety instructions

Each lighting device in the **HERIONOVA** series was designed and manufactured based on state-of-the-art techniques.

It is made of well-selected, high-quality materials. It is carefully tested throughout the production process, from the raw material through to packaging, following a detailed production schedule so as to guarantee that the product is safe and reliable

Material damages, as well as body injuries, may nevertheless still occur while using it.



- This manual is part of the equipment and must always be kept with it.
- Please make sure that ALL instructions/information in this manual is carefully read through.
- Strict compliance with the instructions provided in this manual and on the lighting, equipment is required for its correct use
- Installation and use of the product is recommended only provided it is in perfect conditions, and the user is well-

acquainted with all safety instructions

- CCEA, the manufacturer, waives any responsibility in case of product tampering or improper use.

### 2.1 Proper use of the product

This lighting equipment is fit for being installed inside machine tools, even in a wet environment

### 2.2 Product Safety

#### Electrical Risks

The improper and incorrect use of the equipment may cause bodily injuries and material damages.

- All electrical connection procedures must be carried out by a licensed electrician.
- Switch off the power supply before any installation, maintenance or reparation procedures.
- Ensure to connect to a 24VDC power supply unit. Please respect the polarity of electric conductors.
- Please ensure that the power supply rated tension and frequency meets the requirements shown on the product label.
- Maintenance and reparations must only be carried out by qualified electricians.

### **Risk of explosion**

Risk of explosion might occur upon installing and using this product for applications with a high risk of explosion. It might cause severe body injuries.

- **Do not** install and use this product in hazardous environments (high risk of explosion).

### **Installation and safety**

- Handle the lamp with care and avoid having it drop or being hit even it is still packed, which might cause body injuries, as well as material damages.
- Ensure the original fixing accessories are used, as available from the manufacturer.
- Set up the fixing accessories properly.
- The equipment must be correctly fastened using the proper screws according to the application, place and surface where the product is being mounted.
- Ensure that the fastenings are regularly checked.

### **Danger of dazzling glare due to a white light source**

Avoid staring directly at the light source, as it may cause a temporary reduction of vision. Irritation, aches, damages or accidents may as well occur.

- Avoid staring directly at the light source.
- The device must be adjusted so as to avoid having the light flow directed towards the eyes.

### **Danger caused by inappropriate spare parts.**

Using inappropriate spare parts may cause bodily injuries and material damages.

- **Do not** use spare parts that have not approved by the manufacturer.

### **Damage caused by the presence of laser beams**

Use of the HERIONOVA LED lighting equipment **is not** allowed when a high-power laser – see: a laser cutting system - is operating, since it may damage the LED source.

### **Danger due to high temperatures**

Installing and using the equipment in all the environments where the existing temperature remarkably exceeds the foreseen operating temperature will considerably reduce Led lifetime, while damaging as well the built-in electronic components.

- **Do not** use this device in environments where the operating temperature of the device is exceeded.
- **Operating temperature -4/+113°F (-20°C/+45°C)**
- Avoid direct solar radiation.

### Danger due to repairs

Having the product disassembled or repaired without any appropriate technical /electrical knowledge may cause damages to persons and objects.

- **Do not** try to repair or disassemble the equipment. Please apply to qualified technicians for any issues.
- Any product tampering or modifications not having been approved by the manufacturer will null and void the warranty .

### NOTICE

Dangers where failure to satisfy requirements **may** cause damages to objects.

## 2.3 Damage risk levels



### DANGER

Dangers where noncompliance may **immediately** severe injuries and eventually lead to death.



### WARNING

Dangers where failure to satisfy requirements **may** lead to severe injuries and even to death.



### ATTENTION

Dangers where failure to satisfy requirements **may** lead to injuries.

### 3. Available versions

Please refer to the table hereunder listing all the lighting equipment, for you to identify the version you need and its main features, for you to have the lighting equipment correctly and efficiently installed and used.

**Note:** The product code is found on the brand name label stuck on the product's backside.

- Find out the product code printed on the brand name label and see if you find it on the table hereunder;
- Compare the codes and see if you can identify the same model on the table hereunder;
- The code printed on the brand name label shows the device's week and year of production.

*Note: Do not discard the product labeling which may be requested in case of complaint*

Model	Length	Optic		Power	Power Usage	E. Connection	Weight
HN0221S02	329mm	Diffuser	120°	26.5W	24Vdc	M12-T 4P Male	3.95 lb. (1.79 kg)
HN0321S02	458mm	Diffuser	120°	40W	24Vdc	M12-T 4P Male	4.85 lb. (2.20 kg)
HN0521S02	716mm	Diffuser	120°	66.5W	24Vdc	M12-T 4P Male	7.35 lb. (3.33 kg)
HN0721S02	974mm	Diffuser	120°	93W	24Vdc	M12-T 4P Male	9.75 lb. (4.42 kg)
HN0221S03	329mm	Diffuser	120°	26.5W	24Vdc	CABLE 10 ft (3mt)	4.50 lb. (2.00 kg)
HN0321S03	458mm	Diffuser	120°	40W	24Vdc	CABLE 10 ft (3mt)	5.40 lb. (2.45 kg)
HN0521S03	716mm	Diffuser	120°	66.5W	24Vdc	CABLE 10 ft (3mt)	7.90 lb. (3.58 kg)
HN0721S03	974mm	Diffuser	120°	93W	24Vdc	CABLE 10 ft (3mt)	10.30 lb (4.67 kg)

### 4. Guide to installation

#### 4.1 Product size and accessories

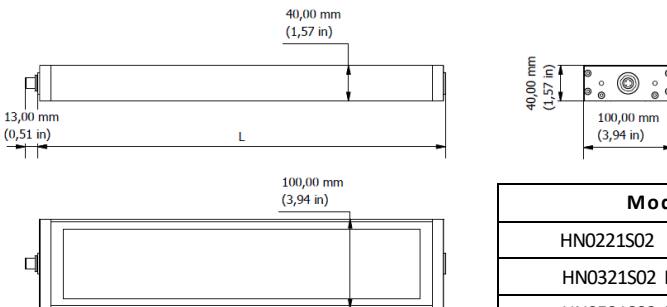

Picture 02

Model	L
HN0221S02 HN0221S03	329 mm (12,95 in)
HN0321S02 HN0321S03	458 mm (18,03 in)
HN0521S02 HN0521S03	716 mm (28,19 in)
HN0721S02 HN0721S03	974 mm (38,35 in)

### 4.2 Mounting accessories

#### HNFX01 SIDE KIT BRACKET

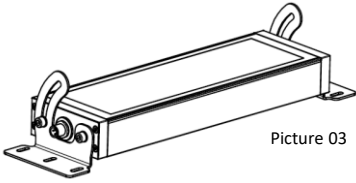

Picture 03

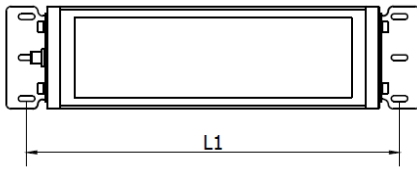
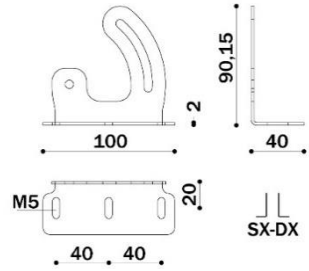
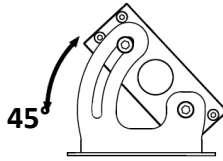

Model	L1- in mm
HN0221S02 HN0221S03	~ 369 mm (14,53 in)
HN0321S02 HN0321S03	~ 498 mm (19,6 in)
HN0521S02 HN0321S03	~ 756 mm (29,76 in)
HN0721S02 HN0721S03	~ 1014 mm (39,92 in)

Interholes

#### HNFX02. Rear Swivel Arm

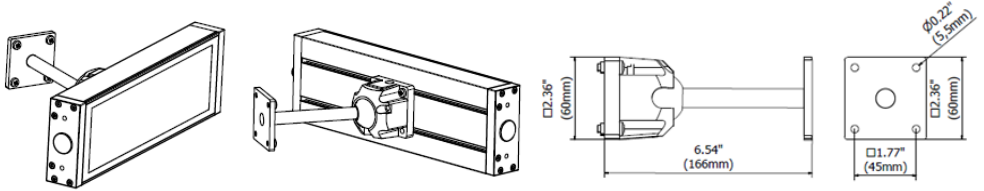

#### FRAMES

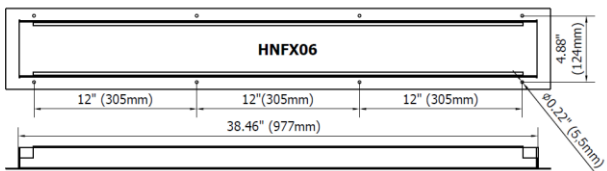
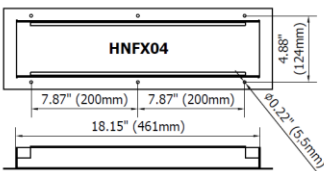
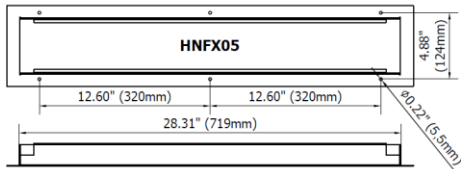
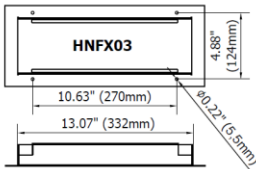
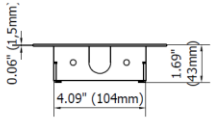



### 4.3 Installation



## ATTENTION

### The lamp fall-down may cause damage to persons and objects

- When mounting the lamp ensure that the original fastenings are used, which you may purchase from the supplier.
- Make sure the mounting accessories have correctly installed



## WARNING

**Switch off the power supply before proceeding to installation.**

### Correct installation using only the original side-mounting brackets HNFx01

The Mounting Kit HNFx01 is Composed of:

- 2 side Brackets 1 left and 1 right made of stainless steel.
- N.4 M6x10 screws with steel handle washers

## NOTICE

To have the lamp correctly mounted without damaging the sealing gaskets, the lamp has to be fixed to the machine structure with the HNFx01 side-mounting brackets locked on the lamp.

- Hook the two side brackets on the lamp sides using the 4 M6 screws provided. (picture 12).

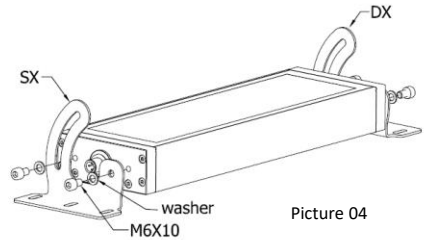

Picture 04

- Bore the fixing holes on the machine surface, as shown at par- 4.2, page 8 (HNFx01 - Side mounting pitch).
- After the fixing holes have been made, fix the lamp to the machine structure using M5 screws of at least 8 mm. length (2 screws for each fastener). The plate where the lamp will be mounted has to be at least 2 mm thick.

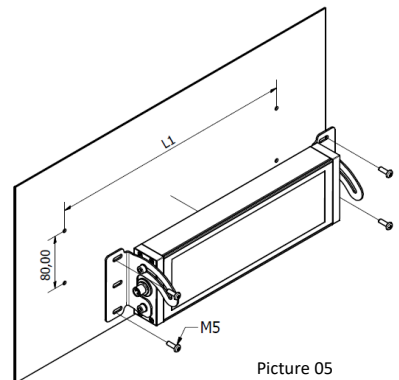

Picture 05

The lamp position can be adjusted by rotating the same with respect to the standing surface once the four M6 screws on each side have been loosened.

Once the right position is found, tighten both screws

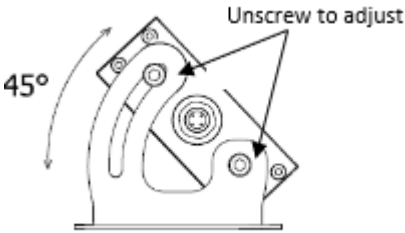

Picture 06

## NOTICE

**ATTENTION!** When side mounting the lamp ensure to never completely loosen the M6 screws allowing for lamp rotation, to avoid having the lamp fall down.

- Proceed in connecting the lamp to a power source

### Correct installation using HNFx02

The item HNFx02 is made of:

- N.1 painted swivel bracket
  - N.4 M5x16 screws
  - N.4 squared nuts supplied with the lamp
- Mark out the positions of the fastening holes on the installation surface. See the sizes table on page 8 (HNFx01) for the drilling center lines.
  - Fasten the swivel mounting bracket to the lamp by tightening the screws at the four sliding nuts in the two lanes on the back of the lamp.

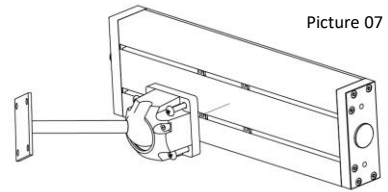

Picture 07

- Fix the lamp to the structure (pict.7). Use M5 screws.

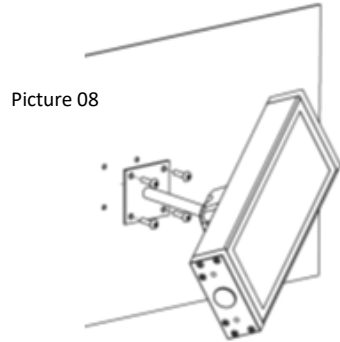

Picture 08

- You can adjust the lamp inclination by unscrewing the 2 M5 screws of the base (see picture below). Once the inclination defined, tighten the screws (pict.8 and 9).

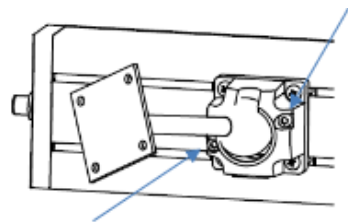

Picture 09

## NOTICE

- **Damaged or broken lamp.**

The brackets as well as the screws tightening have to be checked on a regular basis.

## 5. Plug-in

### NOTICE

#### Material damages caused by liquid leakage

- Use a connector securing the same degree of protection as the lamp, if not greater.
- Ensure that the power cord is correctly plugged into the female connector.

#### 5.1 Low voltage plug-in with M12 connector

### NOTICE

#### Wrong wiring may cause damages to the lamp

- All electrical connections have to be carried out by qualified electricians.
- Please respect the polarity of connectors
- Always use the power cord supplied with the lamp.
- Supply wiring: located in class 2, any wiring, rated min. 20 AWG, min. 50V, min. 90°C.

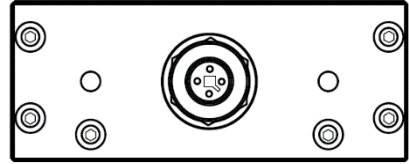

Picture 10

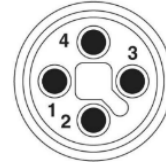

Front view - male side

Picture 11

#### M12-A 4P Male connector (on the lamp)

#### PIN connection

- 1 DC + (24VDC)
- 2 Not connected
- 3 DC - (0VDC)
- 4 Not connected

### NOTICE

Ensure that the supply voltage range to the lamp is closely respected in order to avoid damaging the Led drivers **22 ÷ 36VDC**

## 5.2 Pre-assembled Power Cord for M12 Lighting

### DESCRIPTION

Cod. M12TFC5: M12-A 4 poles, 60VDC connector female with UL PVC Cable, 3G1, 5mmq. Cross-section. Product code includes the above

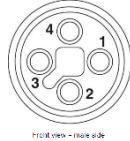

Picture 12

### PIN Conductor

- 1 DC + (24VDC) black 1
- 2 Not connected
- 3 DC - (0VDC) black 2
- 4 Not connected ///

## 5.3 Integrated Power Cord

### PVC Power Cord 2x0,75mmq 90° - 10 ft (3 mt)

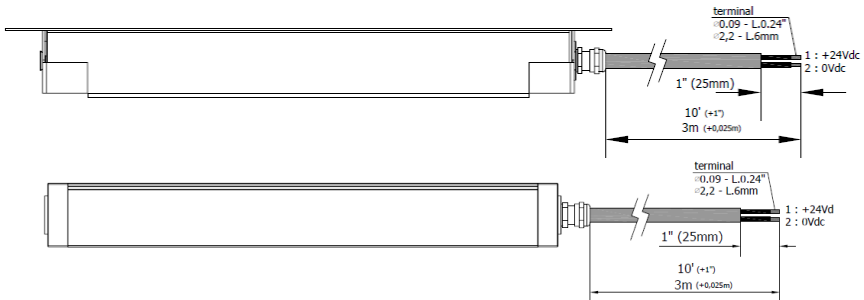

### Connection

- DC + (24VDC)
- DC - (0VDC)

### Conductor

- black1
- black2

## 6. Switch on – Switch off

- The lamp is not equipped with an independent switch on-switch off system.
- The lamp will switch on when plugged-in and switch off when the power is off.

## 7. Problem solving

In case the lamp doesn't turn on:

- Check that the lamp is properly wired to the supply voltage.
- Check that polarity wiring has been carried out correctly.

Please contact CCEA'S Technical support service in case the lamp is defective

**CCEA Technical Support Service**  
**Phone: +39 0444 572083**  
[ccea@ccealights.com](mailto:ccea@ccealights.com)  
[www.ccealights.com](http://www.ccealights.com)

## 8. Replacing the Led light source

The outstanding lifetime of the LED light source, over 60.000 hours, makes it unnecessary to replace the PCB LED if the lamp is properly installed and used following the instructions in this manual. Please contact CCEA's Technical Support service - or your Reseller – in case the replacement of the PCB LED is needed for any defects not covered by the warranty.

## 9. Product maintenance and cleaning



**WARNING**

**Switch off power the supply before any installation, maintenance or reparation procedures.**

This product is maintenance-free.

- Lamp cleaning to be carried out only after it has been switched off and surfaces have cooled down.
- Carefully rinse the lamp surface with a mild cleanser and then wipe off using a soft cloth in order to avoid scoring it.

**NOTICE**

**All material damages caused by liquid leakage may damage the lamp.**

- In case the lamp is working in environments where lubricants or coolers are present, all cleaning operations should be carried out at the end of the working cycle.

## 10. Repairs

### NOTICE

#### All material damages caused by poorly executed repairs may damage the lamp

- All repairs must be carried out by the manufacturer or by qualified technicians.
- Only use spare parts having been approved by the manufacturer.

## 11. Warranty

### Terms of warranty

CCEA ensures that any control procedures or repairs – to be carried out exclusively at/by CCEA Technical service dept. or by any CCEA'S official dealer – are covered throughout the entire product's lifetime. In view of the above, take care to preserve the product label and case, to be submitted if any repair operations are needed.

All repair and spare parts costs will be notified after the defects have been examined.

The warranty does not cover:

- Any transport, packaging or shipping costs;
  - Any damages or deterioration caused by:
- Installation and/or operation carried out following different ways;

- Any unauthorized repairs or attempts to repair the product;
- Equipment operation under environmental conditions other than those specified in the user manual;
- Liquid leakages inside the lamp;
- Failure to follow the safety precautions related to transport and shipping the product back for repair (please make sure to have it shipped back in its original case).

### Period of warranty

The warranty period covers 24 months, starting from the delivery date. CCEA guarantees that the products have no manufacturing defects or malfunctioning.

## 12. Product disposal (EU Regulation)

All the electrical and electronic equipment (WEEE) have to be managed with selective waste sorting and cannot be disposed of as municipal waste, as provided for in Directive 2012/19/Ue.

In view of the above this equipment, all its components, subsystems and the consumables which are an integral part of the product have to be conveyed to the local collection facilities for them to be disposed of in accordance with the current legislation.

Please apply to the council offices of your place of residence in order to know where the collection facilities are located.







### 13. Technical data

**NOTE: Please refer to the data printed on the label or engraved on the lamp.**

Power supply	22÷36VDC
Power input	26,5 - 40 66,5 - 93W (see label)
IEC Class	III
Degree of protection	IP67 Compatible WITH NEMA 6
LED driver	I.D.S. (Integrated System Driver)
Light color temperature	5000K
CRI	80
Operating temperature	-4°F/+113°F ( -20°C/+ 45 °C)

For any further information please refer to the table at page 7

## 14.Symbol keys

	CE Conformity marking
	Protection class III device
<b>IP67</b>	Degree of protection IP67
	UL 2108 STANDARD FOR LOW VOLTAGE LIGHTING SYSTEM – Edition 2 – Revision Date 2017/05/30 CSA C22.2 NO.9.0-96 LUMINAIRES – Edition 1 – Revision Date 1998/07/01. Reaff. 2016
	<b>WARNING:</b> <b>Cancer and Reproductive Harm</b> <a href="http://www.P65Warnings.ca.gov">www.P65Warnings.ca.gov</a>



## 15. Declaration of Conformity

C.C.E.A. SRL, via Piave, 2 - 36077 Altavilla Vicentina (VI), Italy – VAT and Tax number 02374040240 hereby declares that the light equipment named HERIONOVA – to which the present Declaration of Conformity is related - was manufactured by CCEA SRL in accordance with the following Directives: 2014/35/UE on Low Voltage Equipment Safety and the Directive of Electromagnetic Compatibility 89/336/CEE (EMC) 2014/30/UE. The unit complies in particular with the following regulations:

Machinery Directive 2006/42/EC  
Low Voltage Directive 2014/35/EU  
EMC Directive 2014/30/EU

- **Directives**



In Compliance with  
**UL 2108 STANDARD FOR LOW VOLTAGE LIGHTING  
SYSTEM – Edition 2 – Revision Date 2017/05/30  
CSA C22.2 NO.9.0-96 LUMINAIRES – Edition 1 – Revision  
Date 1998/07/01. Reaff. 2016**

- **Certification**



- **Harmonized Standards**

- CEI EN 60598-1 "Lighting equipment. Part 1: General instructions and tests"
- CEI EN 60598-2-4 "Lighting equipment part 2: particular requirements – part 4 Portable general-purpose luminaires".
- CEI EN 62031 "LED modules for general lighting. Safety specifications"
- CEI EN 62384 "DC or AC supplied electronic control gear for LED modules. Performance requirements".

**C.C.E.A. s.r.l**  
36077 Altavilla Vicentina (VI) - Italy  
Tel. ++39 0444 572083  
Fax. ++39 0444 572337  
E-mail: ccea@ccealights.com  
www.ccealights.com

This is a standard product manufactured following a detailed production schedule ensuring that inspections and destructive tests were carried out, for a safe, functional and sustainable product to be delivered.