

**SYRMA  
Series**

**ENGLISH**

**24VDC**

**Installation Manual**



## Table of contents

1. Product description.....	3
2. Safety Warnings .....	4
2.1 Proper use .....	4
2.2 Product safety .....	4
2.3 Risk levels.....	6
3. Available versions.....	7
4. Guide to installation .....	8
4.1 Product sizes .....	8
4.2 Mounting accessories.....	8
4.3 Installation .....	9
5. Plug-in .....	10
5.1 Low voltage plug-in with M12 connector.....	11
5.2 Power cord .....	11
5.3 Integrated Power Cord .....	11
6. Switch on-Switch off .....	12
7. Problem solving .....	12
8. Light source replacement .....	12
9. Product maintenance and cleaning .....	12
10. Repairs.....	13
11. Warranty .....	13
12. Product Disposal .....	14
13. Technical data... ..	14
14. Meaning of symbol keys .....	15
15. Declaration of conformity.....	16

## 1. Product Description



Picture 01



Picture 02

- LED Lighting Equipment suitable for beverage sector, agro-industry, filling machines, presses, CNC
- Extra-slim housing made of aluminum alloy
- 4 sizes from 7.24 in (3184 mm) to 26.14 in (664 mm)
- High degree of protection IP69 (with cable) / IP67 (with M12 connector)
- Reverse polarity protection
- Operating temperature from -4°F to 113°F (-20°C to + 45°C)
- LED lifespan > 60,000 h (L 70)
- Light color 5,000 K - CRI 80
- 24 Vdc via M12 or 10ft. (3m) Cable for more flexibility
- Class III IEC

## 2. Safety instructions

Each lighting device in the **SYRMA** series was designed and manufactured based on state-of-the-art techniques.

It is made of well-selected, high-quality materials. It is carefully tested throughout the production process, from the raw material through to packaging, following a detailed production schedule so as to guarantee that the product is safe and reliable

Material damages, as well as bodily injuries, may nevertheless still occur while using it.



- This manual is part of the equipment and must always be kept with it.
- Please make sure that ALL instructions/information in this manual is carefully read through.
- Strict compliance with the instructions provided in this manual and on the lighting equipment is required for its correct use
- Installation and use of the product is recommended only provided it is in perfect conditions,

and the user is well-acquainted with all safety instructions

- CCEA, the manufacturer, waives any responsibility in case of product tampering or improper use.

### 2.1 Proper use of the product

This lighting equipment is fit for being installed inside machine tools, even in a wet environment

### 2.2 Product safety

#### Electrical Risks

The improper and incorrect use of the equipment may cause bodily injuries and material damages.

- All electrical connection procedures must be carried out by a licensed electrician.
- Switch off the power supply before any installation, maintenance or reparation procedures.
- Ensure to connect to a 24VDC power supply unit. Please respect the polarity of electric conductors.
- Please ensure that the power supply rated tension and frequency meets the requirements shown on the product label.
- Maintenance and reparations must only be carried out by qualified electricians.

**Risk of explosion**

The Risk of the explosion might occur upon installing and using this product for applications with a high risk of explosion. It might cause severe body injuries.

- **Do not** install and use this product in hazardous environments (high risk of explosion).

**Installation and safety**

- Handle the lamp with care and avoid having it drop or being hit even it is still packed which might cause body injuries, as well as material damages.
- Ensure the original mounting accessories are used, as available from the manufacturer.
- Set up the mounting accessories properly.
- The equipment must be correctly fastened using the proper screws according to the application, place and surface where the product is being mounted.
- Ensure that the fastenings are regularly checked.

**Danger of dazzling glare due to a white light source**

Avoid staring directly at the light source, as it may cause a temporary reduction of vision. Irritation, aches, damages or accidents may as well occur.

- Avoid staring directly at the light source.
- The device must be adjusted so as to avoid having the light flow directed towards the eyes.

**Danger caused by inappropriate spare parts.**

Using inappropriate spare parts may cause bodily injuries and material damages.

- **Do not** use spare parts that have not approved by the manufacturer.

**Damage caused by the presence of laser beams**

Use of the SYRMA lighting equipment **is not** allowed when a high power laser – see: a laser cutting system - is operating, since it may damage the LED source.

**Danger due to high temperatures**

Installing and using the equipment in all the environments where the existing temperature remarkably exceeds the foreseen operating temperature will considerably reduce LED lifetime while damaging as well the built-in electronic components.

- **Do not** use this Device in environments where the operating temperature of the device is exceeded.
- **Operating temperature -4/+113°F (-20/+45°C)**
- Avoid direct solar radiation.

### Danger due to repairs

Having the product disassembled or repaired without any appropriate technical /electrical knowledge may cause damages to persons and objects.

- **Do not** try to repair or disassemble the equipment. Please apply to qualified technicians for any issues. Any product tampering or modifications not having been approved by the manufacturer will null and void the warranty.

### NOTICE

Dangers where failure to satisfy requirements **may** cause damages to objects.

## 2.3 Damage risk levels



### DANGER

Dangers where noncompliance may **immediately** severe injuries and eventually lead to death.



### WARNING

Dangers where failure to satisfy requirements **may** lead to severe injuries and even death.



### ATTENTION

Dangers where failure to satisfy requirements **may** lead to injuries.

### 3. Versions

Please refer to the table hereunder listing all the lighting equipment, for you to identify the version you need and its main features, for you to have the lighting equipment correctly and efficiently installed and used.

**Note:** The product code is found on the brand name label stuck on the product's backside.

- Find out the product code printed on the brand name label and see if you find it on the table hereunder;
- Compare the codes and see if you can identify the same model on the table hereunder;
- The code printed on the brand name label shows the device's week and year of production.

*Note: Do not discard the product labeling which may be requested in case of a complaint.*

Versions with M12 Connector A Coding							
Model	Length	Optics		Power	Power Usage	E Connection	Weight
SY0121S01	184mm	Diffuser	120°	6,5W	24Vdc	M12-A 4P Male	1.21 lb (0.55 kg)
SY0221S01	304mm	Diffuser	120°	13W	24Vdc	M12-A 4P Male	1.92 lb (0.90 kg)
SY0321S01	424mm	Diffuser	120°	19,5W	24Vdc	M12-A 4P Male	2.43 lb (1.10 kg)
SY0521S01	664mm	Diffuser	120°	32,5W	24Vdc	M12-A 4P Male	4.01 lb (2,05 kg)
Versions with CABLE							
Model	Length	Optics		Power	Power Usage	E Connection	Weight
SY0121S02	184mm	Diffuser	120°	6,5W	24Vdc	CABLE 10 ft (3mt)	1.59 lb (0.75 kg)
SY0221S02	304mm	Diffuser	120°	13W	24Vdc	CABLE 10 ft (3mt)	2.43 lb (1.10 kg)
SY0321S02	424mm	Diffuser	120°	19,5W	24Vdc	CABLE 10 ft (3mt)	2.87 lb (1.30 kg)
SY0521S02	664mm	Diffuser	120°	32,5W	24Vdc	CABLE 10 ft (3mt)	4.52 lb (2.05 kg)

## 4. Guide to installation

### 4.1 Product size and accessories

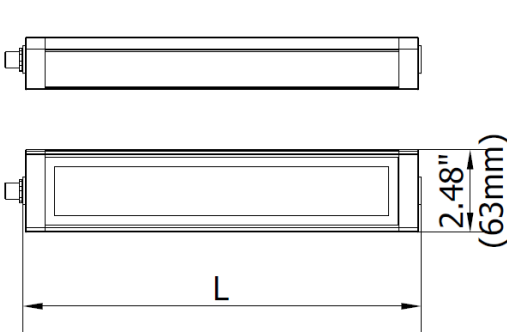

Picture 03

Model	L
<b>SY0121S01</b> <b>SY0121S02</b>	184 mm (7.24 in)
<b>SY0221S01</b> <b>SY0221S02</b>	304 mm (11.97 in)
<b>SY0321S01</b> <b>SY0321S02</b>	424 mm (16.69 in)
<b>SY0521S01</b> <b>SY0521S02</b>	664 mm (26.14 in)

### 4.2 Mounting accessories

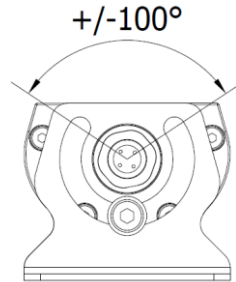
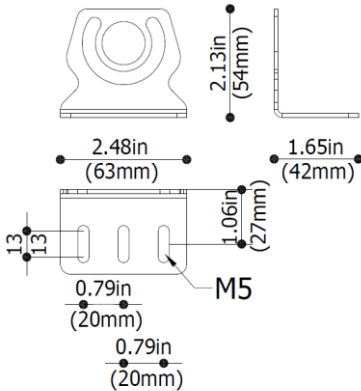

Picture 04

SYFX01 Side mounting brackets



### 4.3 Installation



## ATTENTION

### The lamp fall-down may cause damage to persons and objects

- When mounting the lamp ensure that the original fastenings are used, which you may purchase from the supplier.
- Make sure the mounting accessories have correctly installed



## WARNING

**Switch off power supply before proceeding to installation.**

### Correct installation using only the original side-mounting brackets SYFX01

The SYRMA mounting accessories are made of:

- No.2 side fasteners of chrome-plated steel with M6 screws and steel handle washers
- Direction of the luminous flux adjustable at +/- 100°.

### Installation with SYFX01 side-mounting brackets

- Hook the two side brackets on the lamp sides using the M6.

TCEI M6  
screw +  
washer

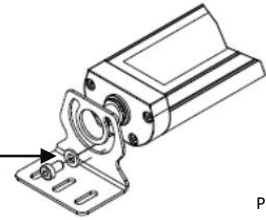

Picture 05

- Bore the fixing holes on the machine surface - Side mounting pitch for side installation:

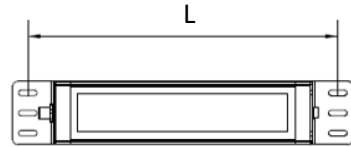

Picture 06

Model	L
SY0121S01 SY0121S02	~ 234 mm (9.21 in)
SY0221S01 SY0221S02	~ 354 mm (13.94 in)
SY0321S01 SY0321S02	~ 474 mm (18,66 in)
SY0521S01 SY0521S02	~ 714 mm (28,11 in)

- After the fixing holes have been made, fix the lamp to the machine structure using M5 screws of at least 8 mm. length (2 screws for each fastener). The plate where the lamp will be mounted has to be at least 2 mm thick.
- The lamp position can be adjusted by rotating the same with respect to the standing surface once the M6 screws on each side have been loosened.

Once the right position is found, tighten both screws (see picture hereunder)

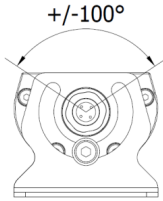

Picture 07

- Use a connector securing the same degree of protection as the lamp, if not greater.
- Ensure that the power cord is correctly plugged into the female connector.

### 5.1 Low voltage plug-in with M12

#### NOTICE

#### NOTICE

#### Damaged or broken lamp

- When side mounting the lamp ensure to never completely loosen the M6 screws allowing for lamp rotation, to avoid having the lamp fall down.
- The side brackets as well as the screws tightening have to be checked on a regular basis.

#### A wrong wiring may cause damages to the lamp.

- All electrical connections have to be carried out by qualified electricians .
- Please respect the polarity of connectors
- Always use the power cord being supplied with the lamp.
- Supply wiring: located in class 2, any wiring, rated min. 20 AWG, min. 50V, min. 90°C.

NOTE: The fastening parts for this lamp are available as accessories. Please For further details, please visit our website: [www.ccealights.com](http://www.ccealights.com)

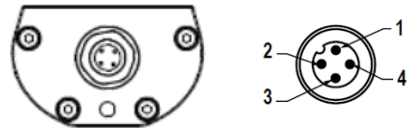

Picture 08

## 5. Plug-in

#### M12 4P Male connector A Coding (on the lamp)

#### PIN connection

- 1 DC + (24VDC)
- 2 Not connected
- 3 DC – (0VDC)
- 4 Not connected

**Material damages caused by liquid leakage**

### 5.2 Pre-assembled Power Cord for M12 Lighting

DESCRIPTION



Cod. **M12AFC5** M12 4 poles A Coding, female connector with pre-assembled UL PVC Cable, 4x0,75mmq. Cross-section. Product code includes the above

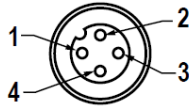

Picture 09

PIN	connection	conductor
1	DC + (24VDC)	brown
2	Not connected	white
3	DC - (0VDC)	blue
4	Not connected	black

### 5.3 Integrated Power Cord

**PVC Power Cord 2x0,75mmq UL90° - 10 ft (3 mt)**  
**Black1: 24Vdc – Black2: 0Vdc**

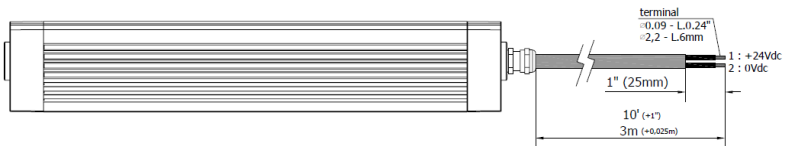

**connection conductors**

DC + (24VDC)	black1
DC - (0VDC)	black2

## 6. Switch on –Switch off

- The lamp is not equipped with an independent switch on-switch off system.
- The lamp will switch on when plugged-in and switch off when the power is off.

## 7. Problem solving

In case the lamp doesn't turn on:

- Check that the lamp is properly wired to the supply voltage.
- Check that polarity wiring has been carried out correctly.

Please contact CCEA'S Technical support service in case the lamp is defective

**CCEA Technical Support Service**  
**Phone: +39 0444 572083**  
[ccea@ccealights.com](mailto:ccea@ccealights.com)  
[www.ccealights.com](http://www.ccealights.com)

## 8. Replacing the LED light source

The outstanding lifetime of the LED light source, over 60.000 hours, makes it unnecessary to replace the PCB LED if the lamp is properly installed and used following the instructions in this manual. Please contact CCEA's Technical Support service - or your Reseller – in case the

replacement of the PCB LED is needed for any defects not covered by the warranty.

## 9. Product maintenance and cleaning



### WARNING

**Switch off the power supply before any installation, maintenance or reparation procedures.**

This product is maintenance-free.

- Lamp cleaning to be carried out only after it has been switched off and surfaces have cooled down.
- Carefully rinse the lamp surface with a mild cleanser and then wipe off using a soft cloth in order to avoid scoring it.

### NOTICE

**All material damages caused by liquid leakage may damage the lamp.**

- In case the lamp is working in environments where lubricants or coolers are present, all cleaning operations should be carried out at the end of the working cycle.

## 10. Repairs

### NOTICE

#### All material damages caused by poorly executed repairs may damage the lamp

- All repairs must be carried out by the manufacturer or by qualified technicians.
- Only use spare parts having been approved by the manufacturer.

- Installation and/or operation carried out following different ways;
- Any unauthorized repairs or attempts to repair the product;
- Equipment operation under environmental conditions other than those specified in the user manual;
- Liquid leakages inside the lamp;
- Failure to follow the safety precautions related to transport and shipping the product back for repair (please make sure to have it shipped back in its original case).

## 11. Warranty

### Terms of warranty

CCEA ensures that any control procedures or repairs – to be carried out exclusively at/by CCEA Technical service dept. or by any CCEA'S official dealer – are covered throughout the entire product's lifetime. In view of the above, take care to preserve the product label and case, to be submitted if any repair operations are needed.

All repair and spare parts costs will be notified after the defects have been examined.

The warranty does not cover:

- Any transport, packaging or shipping costs;
- Any damages or deterioration caused by:

### Period of warranty

The warranty period covers 24 months, starting from the delivery date. CCEA guarantees that the products have no manufacturing defects or malfunctioning.

## 12. Product disposal (EU Regulations)

All the electrical and electronic equipment (WEEE) have to be managed with selective waste sorting and cannot be disposed of as municipal waste, as provided for in Directive 2012/19/Ue.

In view of the above this equipment, all its components, subsystems and the consumables which are an integral part of the product have to be conveyed to the local collection facilities for them to be disposed of in

accordance with the current legislation.

Please apply to the council offices of your place of residence in order to know where the collection facilities are located.





### 13. Technical data

**NOTE: Please refer to the data printed on the label or engraved on the lamp.**

Power supply	21 ÷ 36 VDC
Power input	13-19,5-32,5W (see label)
IEC Class	III
Degree of protection	IP67 compatible with NEMA Type 12 (versions with M12 connector) IP69 compatible with NEMA Type 12 (versions with cable)
LED driver	I.D.S. (Integrated System Driver)
Light color temperature	5000K
CRI	80
Operating temperature	-4/+ 113°F -20/+ 45 °C

For any further information please refer to the table at page 7

## 14. Symbol keys

	CE Conformity marking
	Protection class III device
<b>IP67</b>	Degree of protection IP67
<b>IP69</b>	Degree of protection IP69
	<b>WARNING:</b> <b>Cancer and Reproductive Harm</b> <a href="http://www.P65Warnings.ca.gov">www.P65Warnings.ca.gov</a>

## 15. Declaration of Conformity

C.C.E.A. SRL, via Piave, 2 - 36077 Altavilla Vicentina (VI), Italy – VAT and Tax number 02374040240 hereby declares that the light equipment named SYRMA – to which the present Declaration of Conformity is related - was manufactured by CCEA SRL in accordance with the following Directives: 2014/35/UE on Low Voltage Equipment Safety and the Directive of Electromagnetic Compatibility 89/336/CEE (EMC) 2014/30/UE. The unit complies in particular with the following regulations:  
llowing regulations:

- **Directives:**



**Machinery Directive 2006/42/EC**  
**Low Voltage Directive 2014/35/EU**  
**EMC Directive 2014/30/EU**

- **Harmonized Standards**

CEI EN 60598-1 “Lighting equipment. Part 1: General instructions and tests”

CEI EN 60598-2-4 “Lighting equipment part 2: particular requirements – part 4 Portable general-purpose luminaires”.

CEI EN 62031 “LED modules for general lighting. Safety specifications”.

CEI EN 62384 “DC or AC supplied electronic control gear for LED modules. Performance requirements”.

This is a standard product manufactured following a detailed production schedule ensuring that inspections and destructive tests were carried out, for a safe, functional and sustainable product to be delivered.

C.C.E.A. SRL disclaims any responsibility resulting from tampering and/or wrong use of the device.

Date: \_\_\_\_\_

Week of production: \_\_\_\_\_

Product code: \_\_\_\_\_

CCEA srl  
Via Piave 2  
36077 Altavilla Vicentina (VI) Italy  
Tel +39 0444 572083  
Fax +39 0444 573715  
Email ccea@ccealights.com  
www.ccealights.com